

## N-沟道超级结功率 MOS 管

### N-CHANNEL SUPER JUNCTION POWER MOSFET

SIF65R580

●特点：新高压器件技术 低导通电阻和低传导损耗 封装小 超低栅极电荷导致较低的驱动要求  
100%雪崩测试 符合RoHS规范

●FEATURES: ■New technology for high voltage device ■Low on-resistance and low conduction losses ■small package ■Ultra Low Gate Charge cause lower driving requirements ■100% Avalanche Tested ■ROHS compliant

●应用：功率因素校正（PFC） 开关电源（SMPS） UPS 电源

●APPLICATION: ■Power factor correction (PFC) ■Switched mode power supplies(SMPS) ■Uninterruptible Power Supply (UPS)

●最大额定值（TC=25°C）

●Absolute Maximum Ratings (Tc=25°C) TO-251T/252

参数 PARAMETER	符号 SYMBOL	额定值 VALUE	单位 UNIT
漏-源电压 Drain-source Voltage	V <sub>DS</sub>	650	V
栅-源电压 gate-source Voltage	V <sub>GS</sub>	±30	V
漏极电流 Continuous Drain Current TC=25°C	I <sub>D</sub>	8.0	A
漏极电流 Continuous Drain Current TC=100°C	I <sub>D</sub>	5	A
最大脉冲电流 Drain Current - Pulsed ①	I <sub>DM</sub>	24	A
耗散功率 Power Dissipation	P <sub>tot</sub>	63	W
最高结温 Junction Temperature	T <sub>J</sub>	150	°C
存储温度 Storage Temperature	T <sub>STG</sub>	-55-150	°C
漏源电压斜率 Drain Source voltage slope	dV/dt	50	V/ns
单脉冲雪崩能量 Single Pulse Avalanche Energy ②	E <sub>AS</sub>	150	mJ

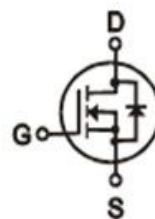

V<sub>DS</sub>=650V

R<sub>DS(ON)</sub>=0.5Ω

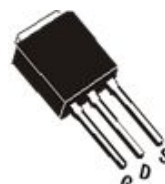

TO-251 T

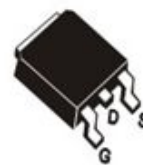

TO-252(DPAK)

●热特性

●Thermal Characteristic

参数 PARAMETER	符号 SYMBOL	TO-251T	TO-252	单位 UNIT
热阻（结到壳） Thermal Resistance, Junction-to-Case (Maximum)	R <sub>thJC</sub>	2.0	2.0	°C /W
热阻（结到环境） Thermal Resistance, Junction-to Ambient (Maximum)	R <sub>thJA</sub>	62.5	62.5	°C /W

●订单信息/ORDERING INFORMATION:

包装形式/PACKING	订货编码/ORDERING CODE	
	普通塑封料/ Normal Package Material	无卤塑封料/Halogen Free
TO-251T 条管装/TUBE PACKING	SIF65R580 TO-251T-TU	SIF65R580 TO-251T-TU-HF
TO-252 条管装/TUBE PACKING	SIF65R580 TO-252-TU	SIF65R580 TO-252-TU-HF
TO-252 编带装/TAPE & REEL PACKING	SIF65R580 TO-252-TR	SIF65R580 TO-252-TR-HF

N-沟道超级结功率 MOS 管

N-CHANNEL SUPER JUNCTION POWER MOSFET

SIF65R580

电特性 (Tc=25°C)

● Electronic Characteristics (Tc=25°C)

参数 PARAMETER	符号 SYMBOL	测试条件 TEST CONDITION	最小值 MIN	典型值 TYP	最大值 MAX	单位 UNIT
漏-源击穿电压 Drain-source Breakdown Voltage	BV <sub>DSS</sub>	V <sub>GS</sub> =0V, I <sub>D</sub> =250μA	650			V
漏-源漏电流 Drain-source Leakage Current	I <sub>DSS</sub>	V <sub>DS</sub> = 650V, V <sub>GS</sub> = 0V, T <sub>J</sub> = 25°C			1	μA
		V <sub>DS</sub> = 650V, V <sub>GS</sub> = 0V, T <sub>J</sub> = 125°C			100	μA
栅极漏电流 Gate-body Leakage Current (V <sub>DS</sub> = 0)	I <sub>GSS</sub>	V <sub>GS</sub> = ±30V			±100	nA
栅极开启电压 Gate Threshold Voltage	V <sub>GS(TH)</sub>	V <sub>GS</sub> =V <sub>DS</sub> , I <sub>D</sub> =250μA	2	3	4	V
漏-源导通电阻 Static Drain-source On Resistance	R <sub>DS(ON)</sub>	V <sub>GS</sub> = 10V, I <sub>D</sub> =4A		0.5	0.58	Ω
跨导 Forward Transconductance	g <sub>fs</sub>	V <sub>DS</sub> = 10V, I <sub>D</sub> =4A		5.5		S
输入电容 Input Capacitance	C <sub>iss</sub>	V <sub>GS</sub> = 0V, V <sub>DS</sub> = 50V F = 1.0MHZ		464		pF
输出电容 Output Capacitance	C <sub>oss</sub>			38		
反向传输电容 Reverse transfer Capacitance	C <sub>rss</sub>			1.47		
栅极电荷 Total Gate Charge	Q <sub>g</sub>	I <sub>D</sub> = 8A, V <sub>DS</sub> = 10V V <sub>GS</sub> = 10V		6.5		nC
栅源电荷 Gate-to-Source Charge	Q <sub>gs</sub>			3.0		nC
栅漏电荷 Gate-to-Drain Charge	Q <sub>gd</sub>			0.9		nC
栅电阻 Intrinsic Gate Resistance	R <sub>G</sub>	f=1MHz open drain		3.7		Ω
开启延迟 Turn -on Delay Time	T <sub>d(on)</sub>	V <sub>DD</sub> =380V, I <sub>D</sub> = 8A R <sub>G</sub> =20Ω V <sub>GS</sub> =10V		18		ns
上升时间 Turn -on Rise Time	t <sub>r</sub>			18		ns
关断延迟 Turn -Off Delay Time	T <sub>d(off)</sub>			27		ns
下降时间 Turn -Off Fall Time	t <sub>f</sub>			22		ns
二极管正向电流 Continuous Diode Forward Current	I <sub>SD</sub>	TC=25°C			8	A
二极管正向压降 Diode Forward Voltage	V <sub>SD</sub>	T <sub>J</sub> =25°C, I <sub>sd</sub> =5.0A V <sub>GS</sub> = 0V		0.7	1.3	V
反向恢复时间 Reverse Recovery Time	t <sub>rr</sub>	T <sub>J</sub> =25°C, I <sub>f</sub> =8.0A di/dt=100A/μs		211		ns
反向恢复电荷 Reverse Recovery Charge	Q <sub>rr</sub>			1.8		μC
反向恢复电流峰值 Peak Reverse Recovery Current	I <sub>rrm</sub>			10.5		A

注释(Notes):

① 脉冲宽度: 以最高节温为限制

Repetitive rating: Pulse width limited by maximum junction temperature

② EAS测试条件: VDD=50V RG=25Ω L=10.8mH, T<sub>J</sub>=25°C

EAS Test condition: VDD=50V RG=25Ω L=10.8mH, T<sub>J</sub>=25°C

N-沟道超级结功率 MOS 管

N-CHANNEL SUPER JUNCTION POWER MOSFET

SIF65R580

● 特性曲线 Characteristic curve



图 1 最大安全工作区曲线

Fig1 Maximum Safe Operating Area

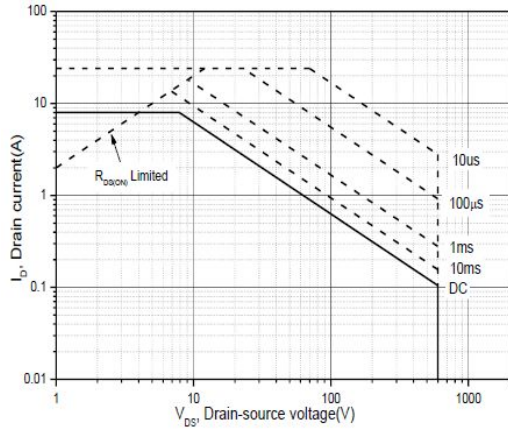

图 2 二极管正向电压曲线

Fig2 Typical Source-Drain Diode Forward Voltage

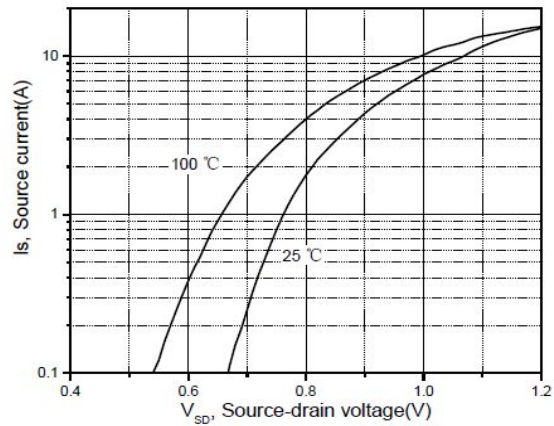

图 3 输出特性曲线, Tc=25°C

Fig3 Typical Output Characteristics

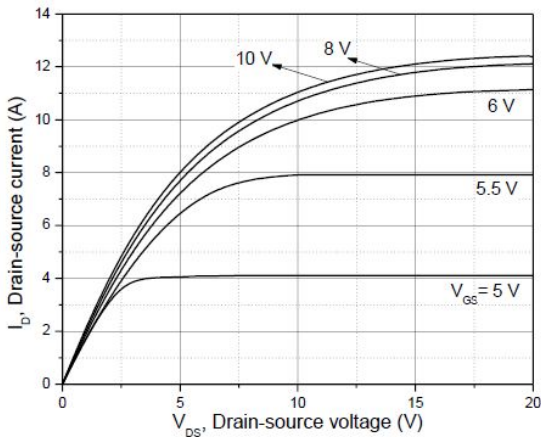

图 4 传输特性曲线

Fig4 Transfer Characteristics

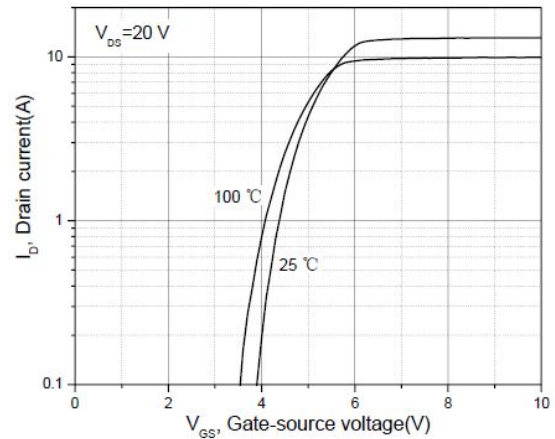

图 5 静态导通电阻与电流曲线

Fig5 Static drain-source On-Resistance

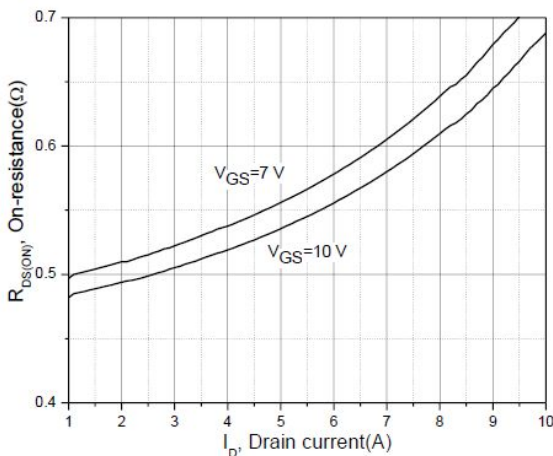

图 6 导通电阻与结温曲线

Fig6 R\_DS(on) VS Junction Temperature

N-沟道超级结功率 MOS 管

N-CHANNEL SUPER JUNCTION POWER MOSFET

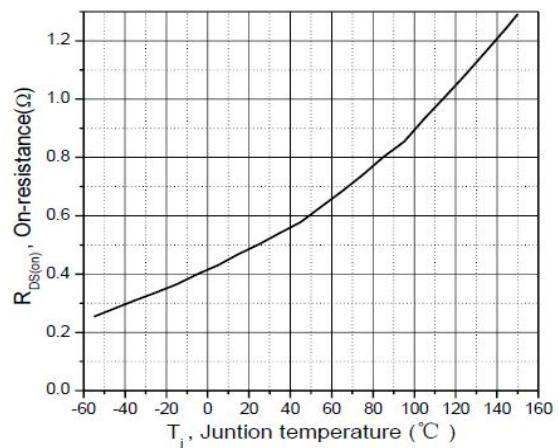
SIF65R580

● 特性曲线 Characteristic curve



图 7 BVDSS 与结温曲线  
Fig7 BVDSS VS Junction Temperature



图 8 最大 ID 与结温曲线  
Fig8 Maximum ID VS Junction Temperature

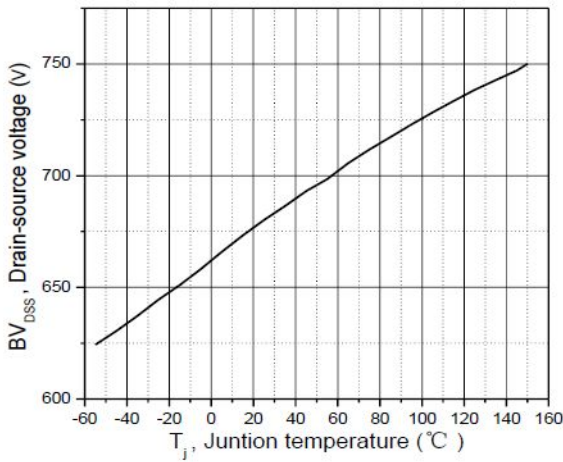

图 9 栅电荷与 VGS 关系曲线  
Fig9 Gate Charge waveforms

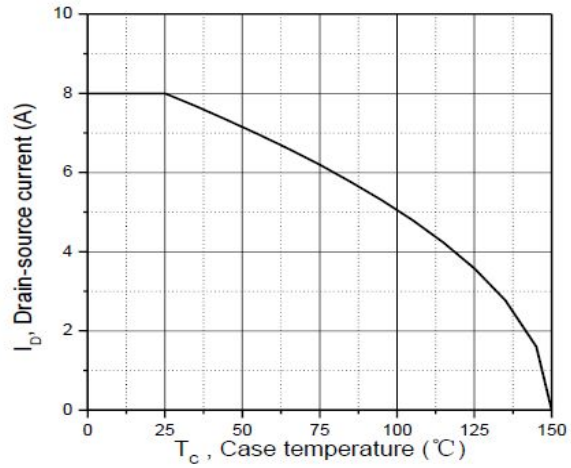

图 10 电容与漏源电压关系曲线  
Fig10 Capacitance

## TO-251T 封装机械尺寸 TO-251T (IPAK) MECHANICAL DATA

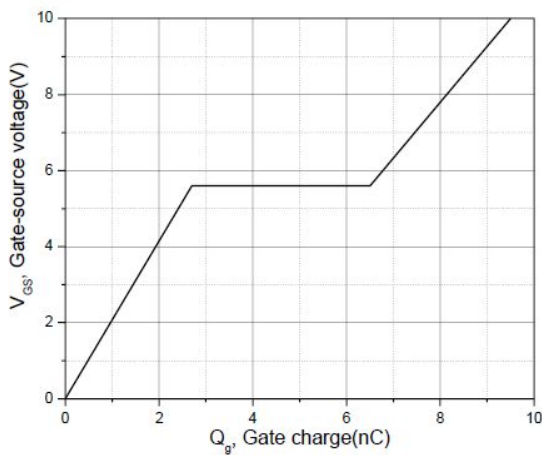
单位:毫米/UNIT: mm

符号/SYMBOL	最小值/min	典型值/nom	最大值/max
A	2.10		2.50
A <sub>1</sub>	0.95		1.30
B	0.80		1.25
b	0.50		0.80
b <sub>1</sub>	0.70		0.80
c	0.45		0.70
c <sub>1</sub>	0.45		0.70
D	6.35		6.80
D <sub>1</sub>	5.10		5.50
E	5.30		6.30
e	2.25	2.30	2.35
L	7.00		9.20
H	0.35		0.45
W <sub>1</sub>	0.30		0.50
W <sub>2</sub>	0.20		0.40

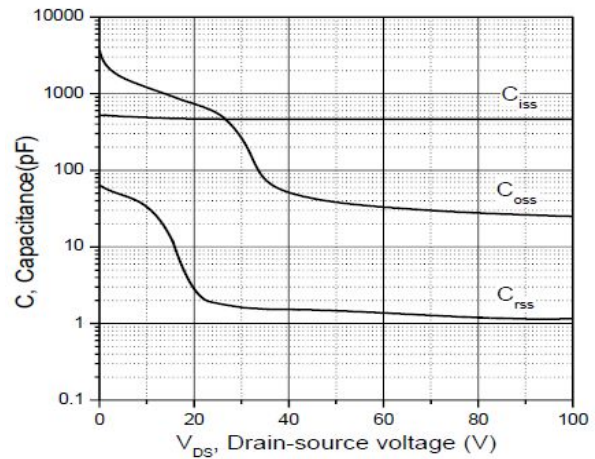
[S/L]

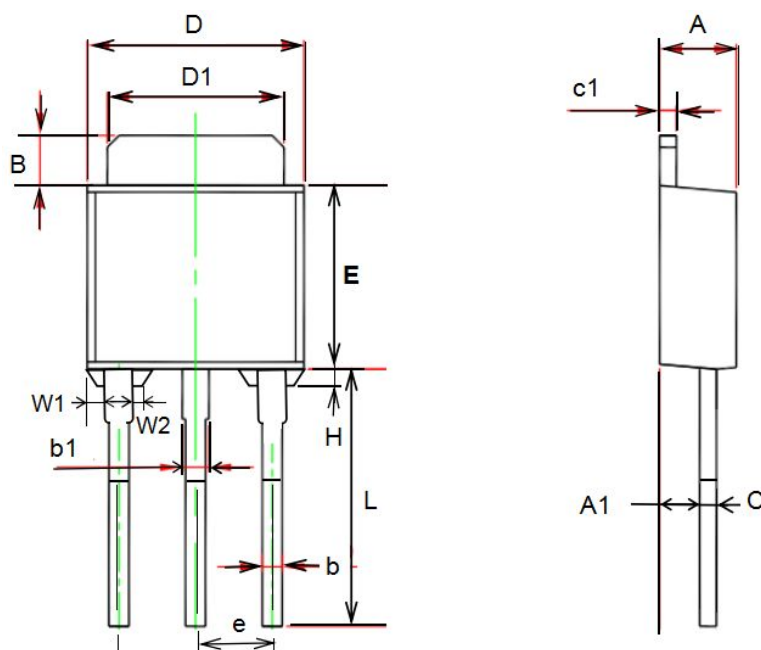

## TO-252 封装机械尺寸 TO-252 MECHANICAL DATA

单位:毫米/UNIT: mm

符号 SYMBOL	最小值 min	最大值 max	符号 SYMBOL	最小值 min	最大值 max
A	2.10	2.50	B	0.85	1.25
b	0.50	0.80	b1	0.70	1.20
b2	0.45	0.70	C	0.45	0.70
D	6.30	6.75	D1	5.10	5.50
E	5.30	6.30	e1	2.25	2.35
L1	9.20	10.60	e2	4.45	4.75
L2	0.90	1.75	L3	0.60	1.10
K	0.00	0.23			

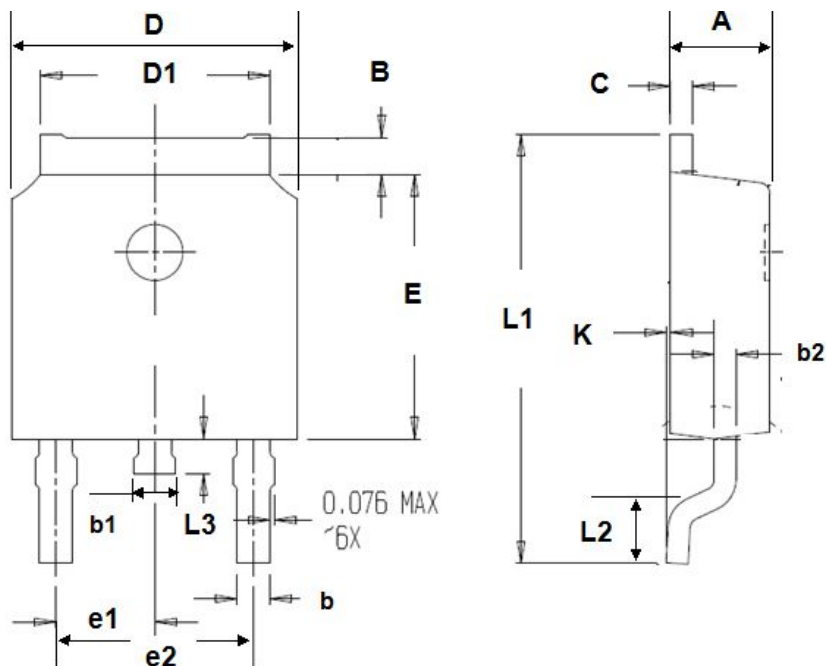

## TO-251S 封装机械尺寸 TO-251S (IPAK) MECHANICAL DATA

单位:毫米/UNIT: mm

符号/SYMBOL	最小值/min	典型值/nom	最大值/max
A	2.20		2.40
b	0.50		0.85
C	0.45	0.50	0.60
D	6.50		6.70
D1	5.10		5.50
E	5.9		6.20
e	2.18	2.29	2.38
L	11.00		12.40
L1	4.8		5.3
L2	3.5		4.2

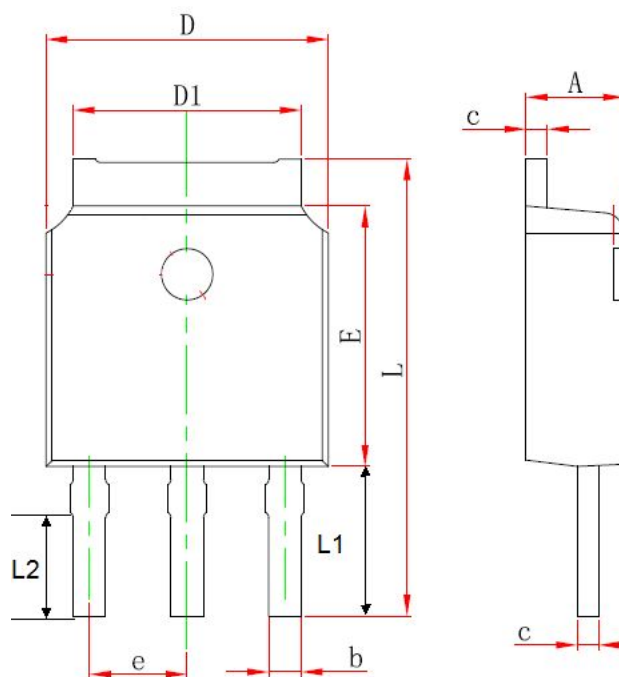

## TO-252 封装机械尺寸 TO-252 MECHANICAL DATA

单位:毫米/UNIT: mm

符号 SYMBOL	最小值 min	最大值 max	符号 SYMBOL	最小值 min	最大值 max
A	2.10	2.50	B	0.85	1.25
b	0.50	0.80	b1	0.50	0.90
b2	0.45	0.70	C	0.45	0.70
D	6.30	6.75	D1	5.10	5.50
E	5.30	6.30	e1	2.25	2.35
L1	9.20	10.60	e2	4.45	4.75
L2	0.90	1.75	L3	0.60	1.10
K	0.00	0.23			

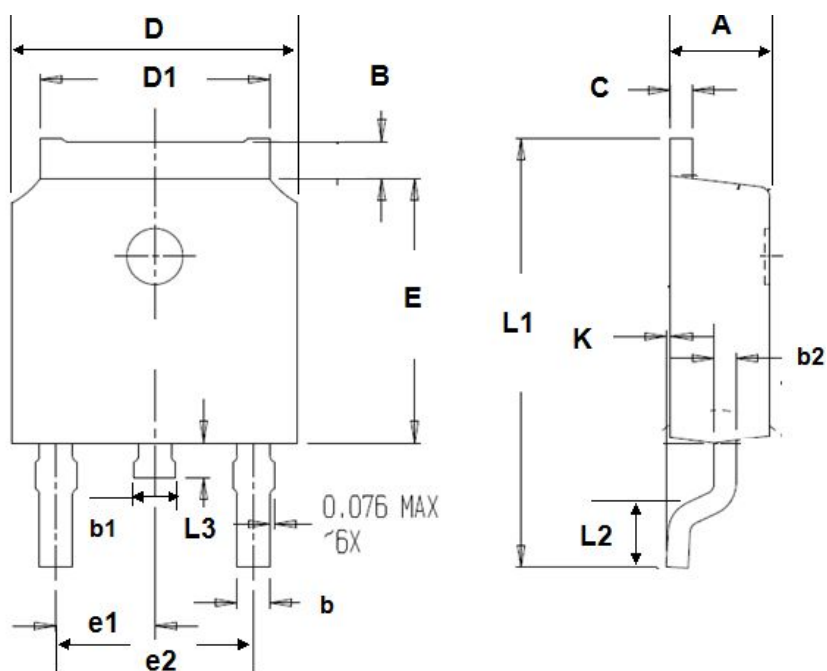



## TO-252 编带规格尺寸 TO-252 TAPE AND REEL DATA

单位:毫米/UNIT: mm

符号 SYMBOL	最小值 min	典型值 nom	最大值 max	符号 SYMBOL	最小值 min	典型值 nom	最大值 max
A0	6.80	6.90	7.00	B0	10.40	10.50	10.60
K0	2.60	2.70	2.90	K1	2.40	2.50	2.60
F	7.40	7.50	7.60	K2	1.60	1.70	1.80
W	15.90	16.00	16.10	P1	7.90	8.00	8.10

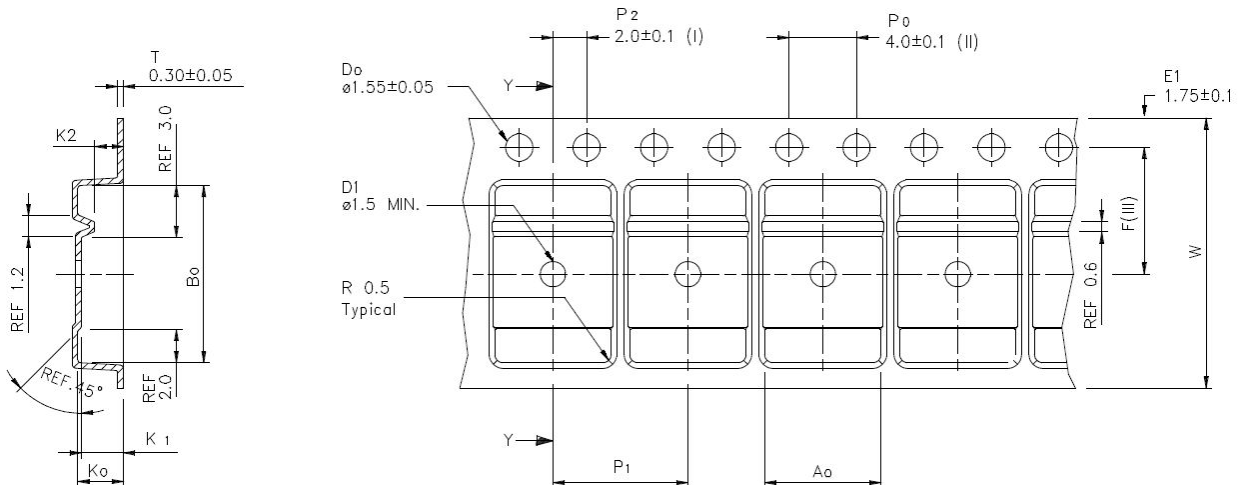

使用供带方向/USER DIRECTION OF FEED

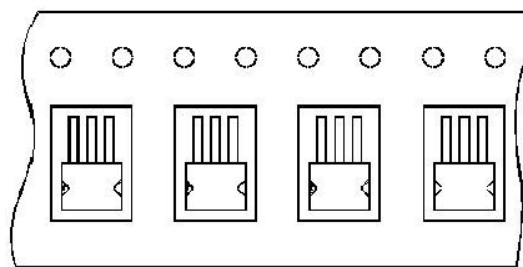

编带器件定位/UNIT ORIENTATION