

**NPN BUL 系列晶体管 / BUL SERIES TRANSISTORS**

**BUL6822A**

- 特点：耐压高 开关速度快 安全工作区宽 符合 RoHS 规范
- FEATURES: ■HIGH VOLTAGE CAPABILITY ■HIGH SPEED SWITCHING ■WIDE SOA ■RoHS COMPLIANT
- 应用：节能灯 电子镇流器
- APPLICATION: ■FLUORESCENT LAMP ■ELECTRONIC BALLAST

●最大额定值 (Tc=25°C)  
●Absolute Maximum Ratings (Tc=25°C) **TO-92/92S**

参数 PARAMETER	符号 SYMBOL	额定值 VALUE	单位 UNIT
集电极-基极电压 Collector-Base Voltage	V <sub>CB0</sub>	600	V
集电极-发射极电压 Collector-Emitter Voltage	V <sub>CEO</sub>	400	V
发射极-基极电压 Emitter-Base Voltage	V <sub>EBO</sub>	9	V
集电极电流 Collector Current	I <sub>C</sub>	1.0	A
集电极耗散功率 Total Power Dissipation	P <sub>tot</sub>	12	W
最高工作温度 Junction Temperature	T <sub>j</sub>	150	°C
贮存温度 Storage Temperature	T <sub>stg</sub>	-65-150	°C

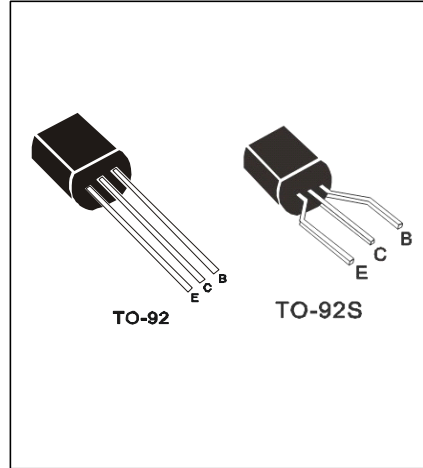

●电特性 (Tc=25°C)  
●Electronic Characteristics (Tc=25°C)

参数名称 CHARACTERISTICS	符号 SYMBOL	测试条件 TEST CONDITION	最小值 MIN	最大值 MAX	单位 UNIT
集电极-基极截止电流 Collector-Base Cutoff Current	I <sub>CB0</sub>	V <sub>CB</sub> =600V		100	μA
集电极-发射极截止电流 Collector-Emitter Cutoff Current	I <sub>CEO</sub>	V <sub>CE</sub> =400V, I <sub>B</sub> =0		250	μA
集电极-基极电压 Collector-Base Voltage	V <sub>CB0</sub>	I <sub>C</sub> =1mA, I <sub>E</sub> =0	600		V
集电极-发射极电压 Collector-Emitter Voltage	V <sub>CEO</sub>	I <sub>C</sub> =10mA, I <sub>B</sub> =0	400		V
发射极-基极电压 Emitter-Base Voltage	V <sub>EBO</sub>	I <sub>E</sub> =1mA, I <sub>C</sub> =0	9		V
集电极-发射极饱和电压 Collector-Emitter Saturation Voltage	V <sub>cesat</sub>	I <sub>C</sub> =200mA, I <sub>B</sub> =40mA		0.3	V
		I <sub>C</sub> =750mA, I <sub>B</sub> =250mA		0.5	
发射极-基极饱和电压 Base-Emitter Saturation Voltage	V <sub>besat</sub>	I <sub>C</sub> =200mA, I <sub>B</sub> =40mA		1.2	V
电流放大倍数 DC Current Gain	h <sub>FE</sub>	V <sub>CE</sub> =5V, I <sub>C</sub> =1mA	7		
		V <sub>CE</sub> =10V, I <sub>C</sub> =0.1A	10	40	
		V <sub>CE</sub> =5V, I <sub>C</sub> =1A	5		
贮存时间/Storage Time	t <sub>s</sub>	V <sub>CC</sub> =5V, I <sub>C</sub> =0.1A, (UI9600)	2.0	4.5	μs
下降时间/Falling Time	t <sub>f</sub>			1.0	

●订单信息/ORDERING INFORMATION:

包装形式/PACKING	订货编码/ORDERING CODE	
	普通塑封料/Normal Package Material	无卤塑封料/Halogen Free
TO-92 普通袋装/NORMAL PACKING	BUL6822A TO-92	BUL6822A TO-92-HF
<b>TO-92S</b> 普通袋装/NORMAL PACKING	BUL6822A TO-92S	BUL6822A TO-92S-HF
TO-92 盒式编带/AMMOPACK	BUL6822A TO-92-AP	BUL6822A TO-92-AP-HF

**NPN BUL 系列晶体管 / BUL SERIES TRANSISTORS**

**BUL6822A**

**SOA (DC)**

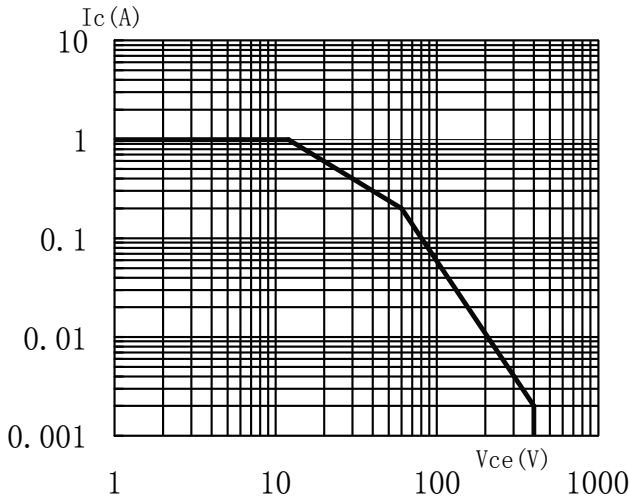

**$P_{tot} \propto T_j$**

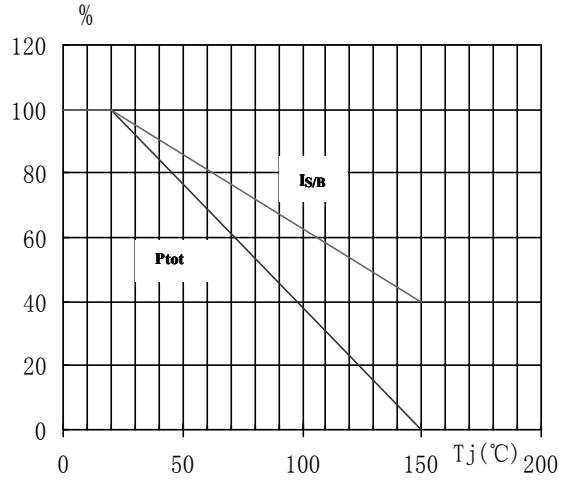

**$h_{FE} - I_c$**

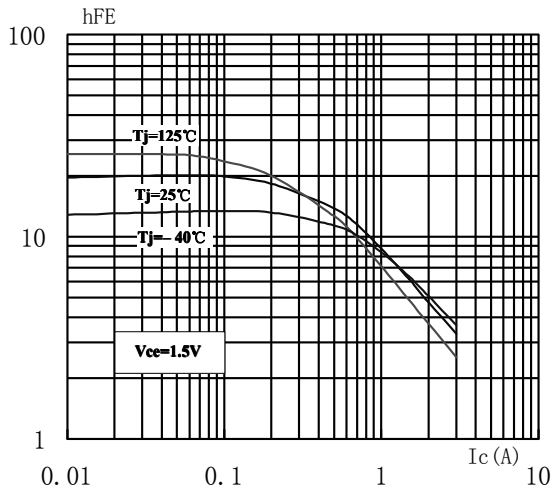

**$h_{FE} - I_c$**

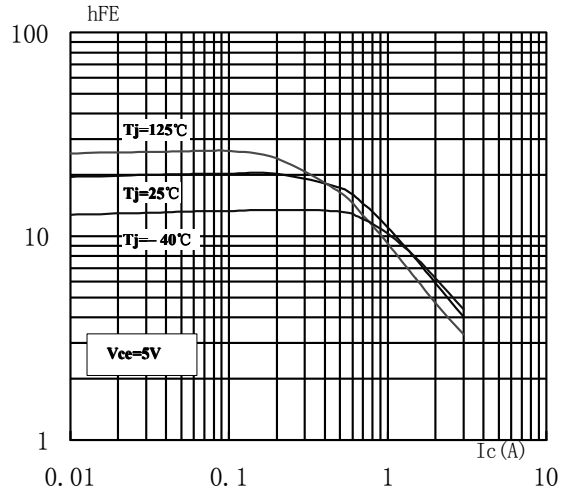

**$V_{cesat} - I_c$**

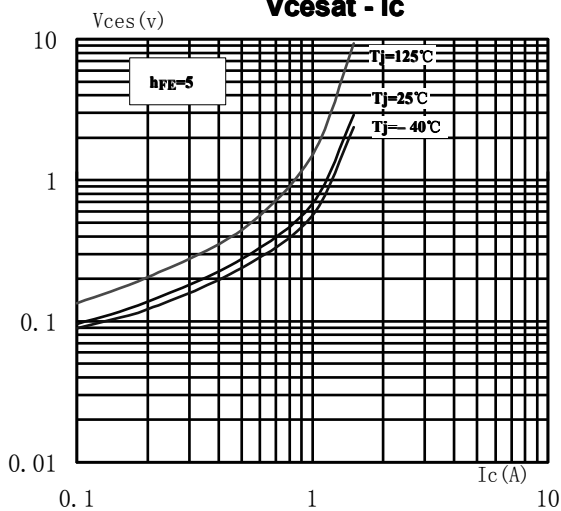

**$V_{besat} - I_c$**

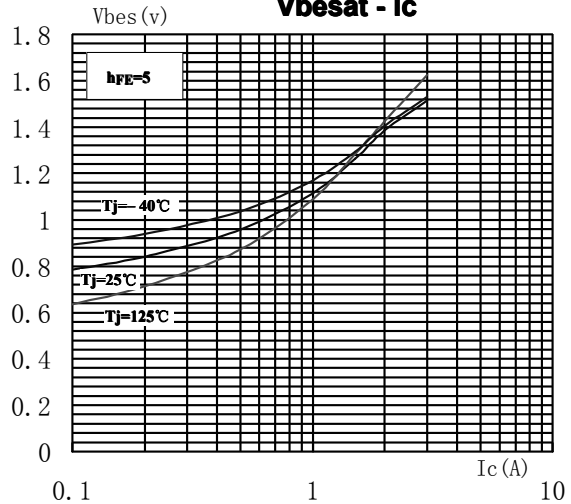

## TO-92 封装机械尺寸 TO-92 MECHANICAL DATA

单位:毫米/UNIT: mm

符号/SYMBOL	最小值/min	典型值/nom	最大值/max
A	4.30		5.30
b	0.30		0.55
c	0.30		0.50
$\phi D$	4.30		5.20
D			
d	1.00		1.70
E	3.20		4.20
e		2.54	
e1		1.27	
L	12.70		15.00
L1	1.50		2.00

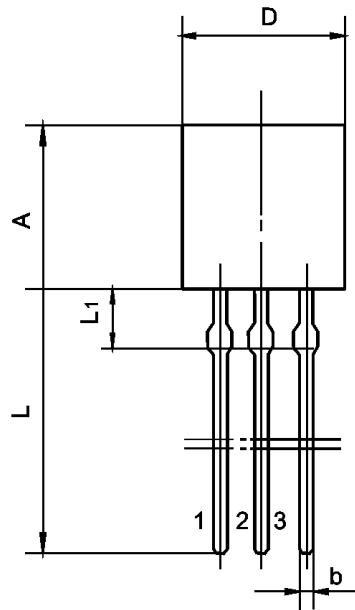
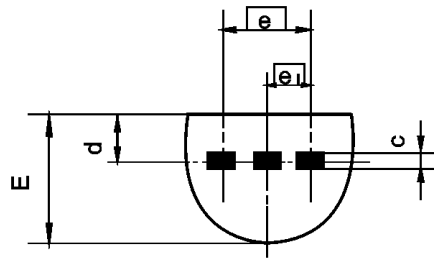

## TO-92S 封装机械尺寸 TO-92S MECHANICAL DATA

单位:毫米/UNIT: mm

符号/SYMBOL	最小值/min	典型值/nom	最大值/max
A	4.30		5.30
b	0.30		0.55
c	0.30		0.50
D( $\phi$ D)	4.30		5.20
d	1.00		1.70
E	3.20		4.20
F	2.25	2.40	2.55
L	3.20		3.80
L1	2.60		2.70

