

NPN D 系列晶体管 / D SERIES TRANSISTORS

BLD139D

- 特点: 耐压高 开关速度快 安全工作区宽 符合 RoHS 规范
- FEATURES: ■HIGH VOLTAGE CAPABILITY ■HIGH SPEED SWITCHING ■WIDE SOA ■RoHS COMPLIANT
- 应用: 节能灯 电子镇流器 电子变压器 开关电源
- APPLICATION: ■FLUORESCENT LAMP ■ELECTRONIC BALLAST ■ELECTRONIC TRANSFORMER ■SWITCH MODE POWER SUPPLY

●最大额定值 (Tc=25°C)

●Absolute Maximum Ratings (Tc=25°C) TO-220/220S

参数 PARAMETER	符号 SYMBOL	额定值 VALUE	单位 UNIT
集电极-基极电压 Collector-Base Voltage	V _{CB0}	700	V
集电极-发射极电压 Collector-Emitter Voltage	V _{CEO}	400	V
发射极-基极电压 Emitter-Base Voltage	V _{EBO}	9	V
集电极电流 Collector Current	I _c	12	A
集电极耗散功率 Total Power Dissipation	P _{tot}	100	W
最高工作温度 Junction Temperature	T _j	150	°C
贮存温度 Storage Temperature	T _{stg}	-65-150	°C

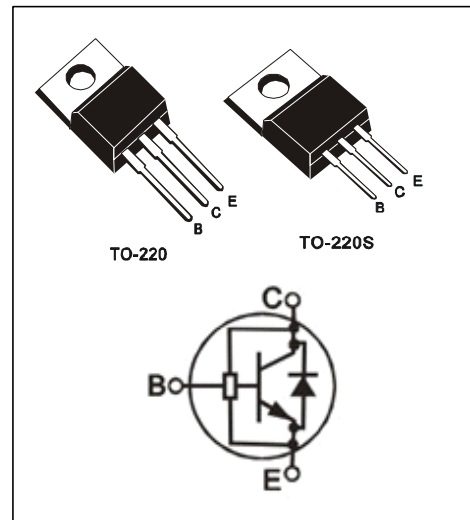

●电特性 (Tc=25°C)

●Electronic Characteristics (Tc=25°C)

参数名称 CHARACTERISTICS	符号 SYMBOL	测试条件 TEST CONDITION	最小值 MIN	最大值 MAX	单位 UNIT
集电极-基极截止电流 Collector-Base Cutoff Current	I _{CB0}	V _{CB} =700V		100	μA
集电极-发射极截止电流 Collector-Emitter Cutoff Current	I _{CEO}	V _{CE} =400V, I _B =0		250	μA
集电极-基极电压 Collector-Base Voltage	V _{CB0}	I _C =1mA, I _E =0	700		V
集电极-发射极电压 Collector-Emitter Voltage	V _{CEO}	I _c =10mA, I _B =0	400		V
发射极-基极电压 Emitter-Base Voltage	V _{EBO}	I _E =1mA, I _C =0	9		V
集电极-发射极饱和电压 Collector-Emitter Saturation Voltage	V _{cesat}	I _C =8.0A, I _B =1.6A		0.6	V
		I _C =12.0A, I _B =3.0A		0.9	
发射极-基极饱和电压 Base-Emitter Saturation Voltage	V _{besat}	I _C =8A, I _B =1.6A		1.2	V
电流放大倍数 DC Current Gain	h _{FE}	V _{CE} =5V, I _C =10mA	7		
		V _{CE} =5V, I _C =3.0A	10	40	
		V _{CE} =5V, I _C =12A	5		
贮存时间/Storage Time	t _s	V _{CC} =5V, I _C =0.5A (UI9600)	5.0	8.0	μs
下降时间/Falling Time	t _f			0.8	
内置二极管正向压降 Diode Forward Voltage	V _F	I _F =6.0A		1.6	V

●订单信息/ORDERING INFORMATION:

包装形式/PACKING	订货编码/ORDERING CODE	
	普通塑封料/ Normal Package Material	无卤塑封料/Halogen Free
TO-220 普通袋装/NORMAL PACKING	BLD139D TO-220	BLD139D TO-220-HF
TO-220S 普通袋装/NORMAL PACKING	BLD139D TO-220S	BLD139D TO-220S-HF
TO-220 条管装/TUBE PACKING	BLD139D TO-220-TU	BLD139D TO-220-TU-HF

NPN D 系列晶体管 / D SERIES TRANSISTORS

BLD139D

SOA (DC)

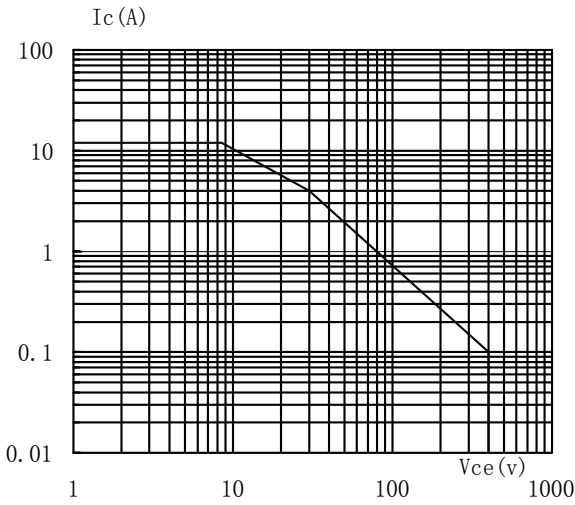

$P_{tot} \propto T_j$

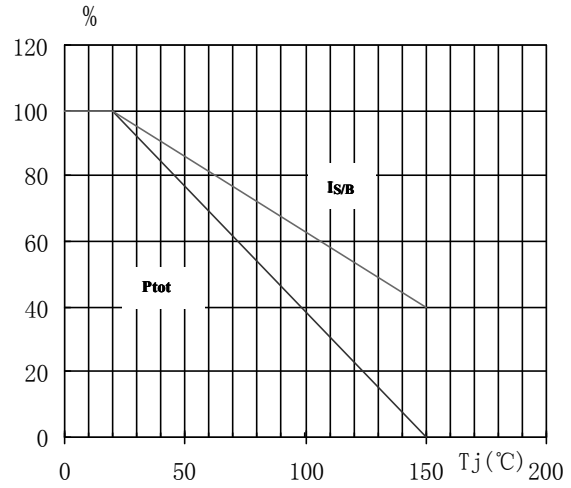

$h_{FE} - I_c$

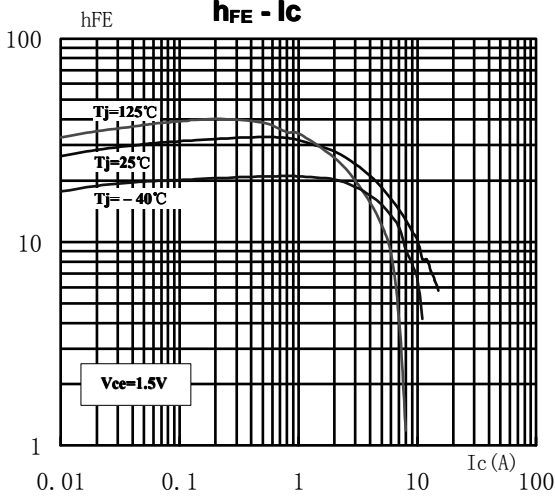

$h_{FE} - I_c$

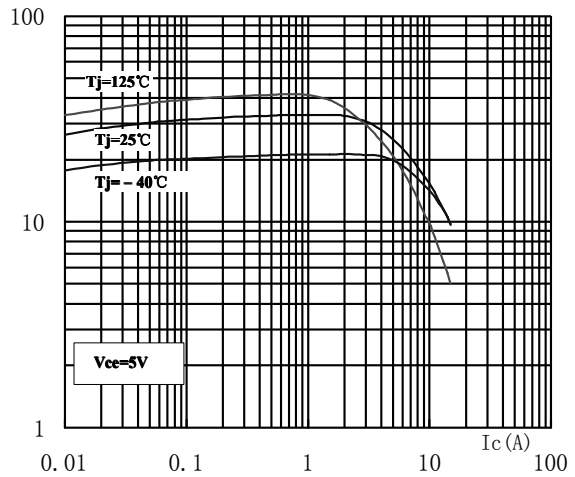

$V_{cesat} - I_c$

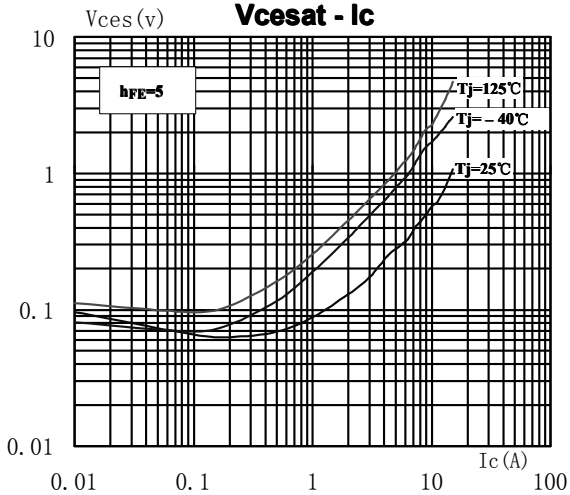

$V_{besat} - I_c$

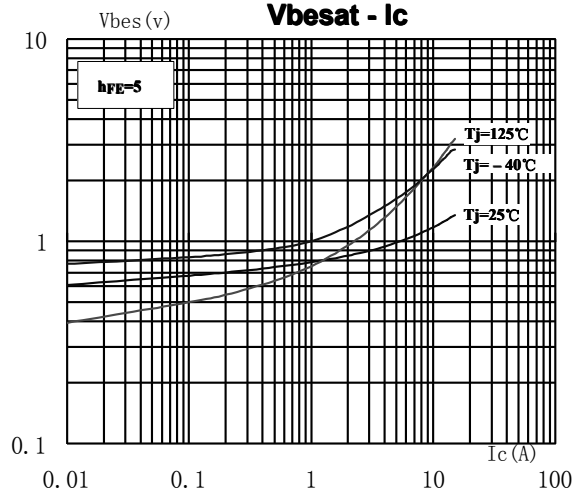

TO-220 封装机械尺寸 TO-220 MECHANICAL DATA

单位：毫米/UNIT: mm

符号 SYMBOL	最小值 min	典型值 nom	最大值 max	符号 SYMBOL	最小值 min	典型值 nom	最大值 max
A	4.00		4.80	E	9.90		10.70
B	1.20		1.50	e		2.54	
B1	1.00		1.40	F	1.10		1.45
b1	0.65		1.00	L	12.50		14.50
c	0.35		0.75	L1	3.00	3.50	4.00
D	15.00		16.50	Q	2.50		3.00
D1	5.90		6.90	Q1	2.00		3.00
				φP	3.60		3.90

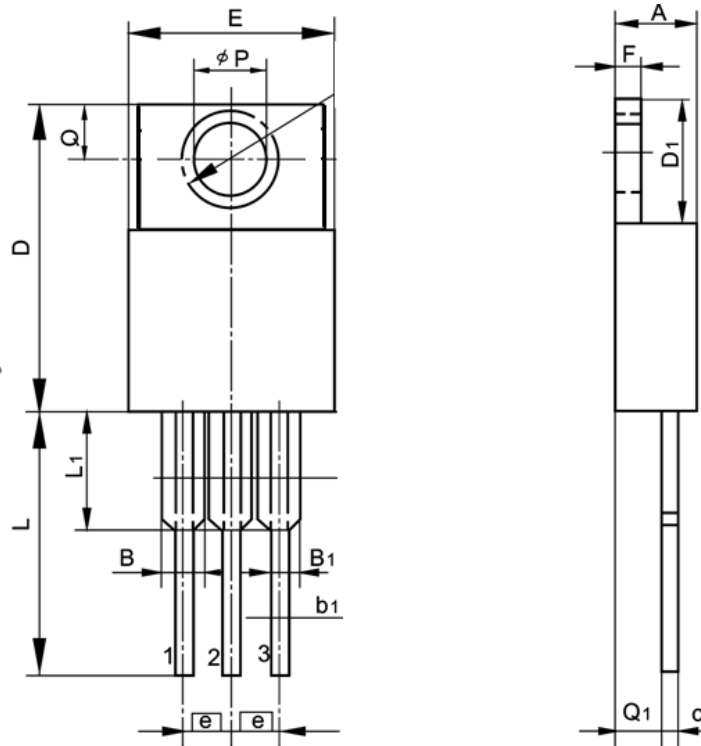

TO-220S 封装机械尺寸

TO-220S MECHANICAL DATA

单位：毫米/UNIT: mm

符号 SYMBOL	最小值 min	典型值 nom	最大值 max	符号 SYMBOL	最小值 min	典型值 nom	最大值 max
A	4.00		4.80	E	9.90		10.70
B	1.27		1.50	e		2.54	
B1			1.40	F	1.20		1.45
b1	0.75		1.00	L	3.20		3.80
c	0.38		0.75	L1			3.50
D	15.00		16.5	φP	3.60		3.90
D1	5.90		6.60	Q	2.50		3.00
				Q1	2.00		3.00

