

NPN D 系列晶体管/ D SERIES TRANSISTORS

BLD123DA

- 特点：耐压高 开关速度快 安全工作区宽 符合 RoHS 规范
- FEATURES: ■HIGH VOLTAGE CAPABILITY ■HIGH SPEED SWITCHING ■WIDE SOA ■RoHS COMPLIANT
- 应用：电子镇流器 节能灯
- APPLICATIONS: ■ELECTRONIC BALLAST ■FLUORESCENT LAMP

- 最大额定值 (Tc=25°C)
- Absolute Maximum Ratings (Tc=25°C) TO-92/92S

参数 PARAMETER	符号 SYMBOL	额定值 VALUE	单位 UNIT
集电极-基极电压 Collector-Base Voltage	V _{CB0}	700	V
集电极-发射极电压 Collector-Emitter Voltage	V _{CEO}	400	V
发射极-基极电压 Emitter-Base Voltage	V _{EBO}	9	V
集电极电流 Collector Current	I _C	2.0	A
集电极耗散功率 Total Power Dissipation	P _{tot}	18	W
最高工作温度 Junction Temperature	T _J	150	°C
贮存时间 Storage Temperature	T _{stg}	-65-150	°C

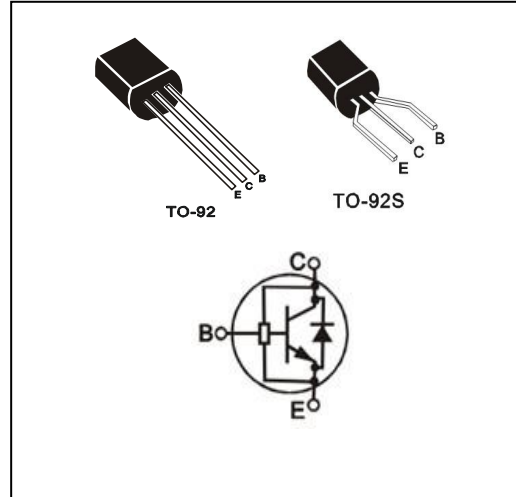

- 电特性 (Tc=25°C)
- Electrical Characteristics (Tc=25°C)

参数名称 CHARACTERISTIC	符号 SYMBOL	测试条件 TEST CONDITION	最小值 MIN	最大值 MAX	单位 UNIT
集电极-基极截止电流 Collector-Base Cutoff Current	I _{CB0}	V _{CB} =700V		100	μA
集电极-发射极截止电流 Collector-Emitter Cutoff Current	I _{CEO}	V _{CE} =400V, I _B =0		250	μA
集电极-基极电压 Collector-Base Voltage	V _{CB0}	I _C =1mA, I _E =0	700		V
集电极-发射极电压 Collector-Emitter Voltage	V _{CEO}	I _C =10mA, I _B =0	400		V
发射极-基极电压 Emitter-Base Voltage	V _{EBO}	I _E =1mA, I _C =0	9		V
集电极-发射极饱和电压 Collector-Emitter Saturation Voltage	V _{cesat}	I _C =0.5A, I _B =0.1A		0.3	V
		I _C =1.0A, I _B =0.25A		0.4	
		I _C =1.5A, I _B =0.5A		0.9	
发射极-基极饱和电压 Base-Emitter Saturation Voltage	V _{besat}	I _C =0.5A, I _B =0.1A		1.2	V
电流放大倍数 DC Current Gain	h _{FE}	V _{CE} =5V, I _C =1mA	8		
		V _{CE} =5V, I _C =0.2A	20	35	
		V _{CE} =5V, I _C =2.0A	5		
贮存时间/Storage Time	t _s	V _{CC} =5V, I _C =0.25A (UI9600)	2.0	6.0	μs
下降时间啊/Falling Time	t _f			0.8	μs

●订单信息/ORDERING INFORMATION:

包装形式/PACKING	订货编码/ORDERING CODE	
	普通塑封料/ Normal Package Material	无卤塑封料/Halogen Free
TO-92 普通袋装/NORMAL PACKING	BLD123DA TO-92	BLD123DA TO-92-HF
TO-92S 普通袋装/NORMAL PACKING	BLD123DA TO-92S	BLD123DA TO-92S-HF
TO-92 盒式编带/AMMOPACK	BLD123DA TO-92-AP	BLD123DA TO-92-AP-HF

NPN D 系列晶体管 / D SERIES TRANSISTORS

BLD123DA

SOA (DC)

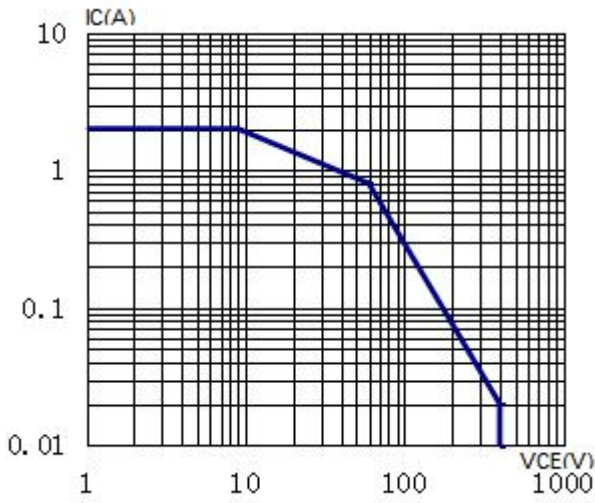

$P_{tot} \propto T_j$

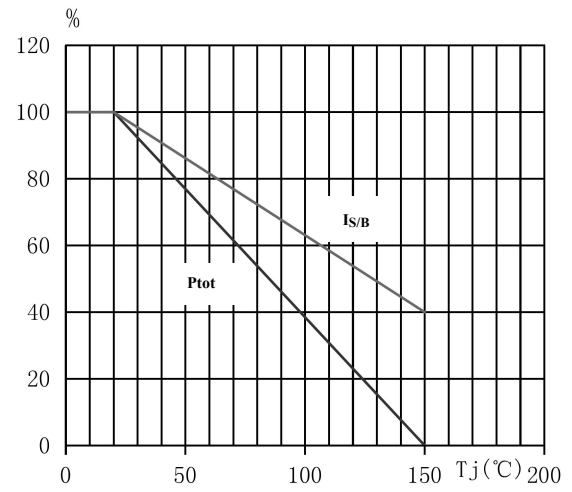

$h_{FE} - I_c$

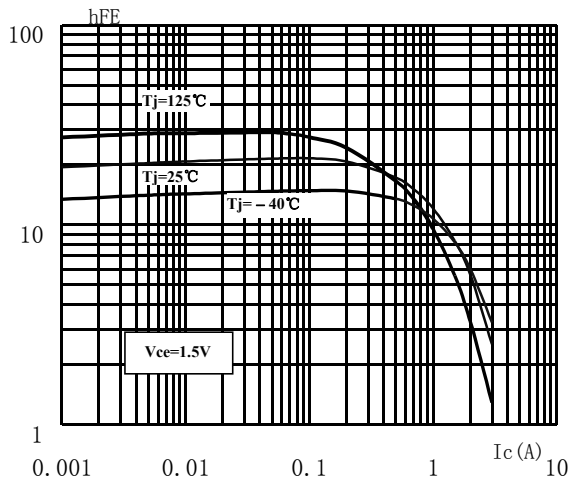

$h_{FE} - I_c$

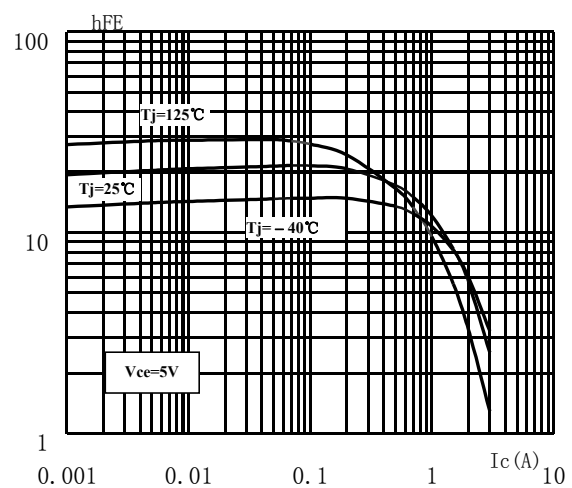

$V_{cesat} - I_c$

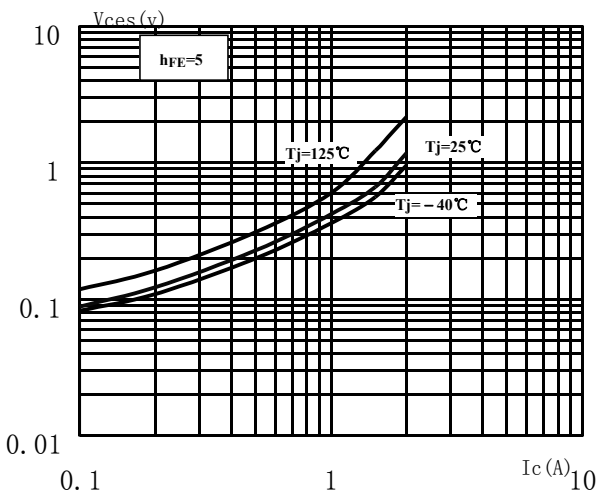

$V_{besat} - I_c$

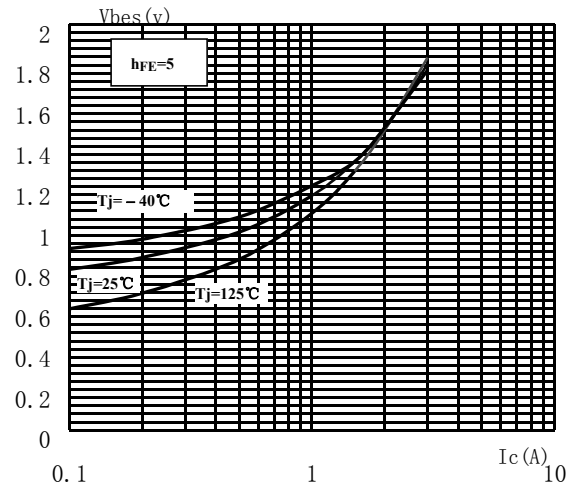

TO-92 封装机械尺寸 TO-92 MECHANICAL DATA

单位:毫米/UNIT: mm

符号/SYMBOL	最小值/min	典型值/nom	最大值/max
A	4.30		5.30
b	0.30		0.55
c	0.30		0.50
ϕD D	4.30		5.20
d	1.00		1.70
E	3.20		4.20
e		2.54	
e1		1.27	
L	12.70		15.00
L1	1.50		2.00

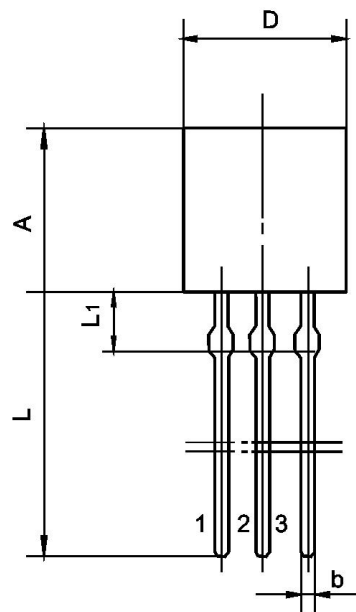
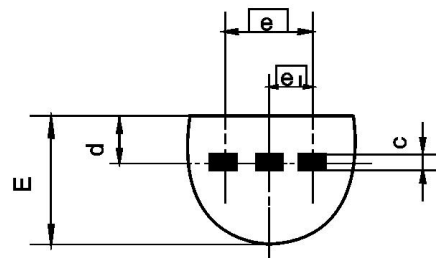

TO-92S 封装机械尺寸 TO-92S MECHANICAL DATA

单位:毫米/UNIT: mm

符号/SYMBOL	最小值/min	典型值/nom	最大值/max
A	4.30		5.30
b	0.30		0.55
c	0.30		0.50
D(ϕ D)	4.30		5.20
d	1.00		1.70
E	3.20		4.20
F	2.25	2.40	2.55
L	3.20		3.80
L1	2.60		2.70

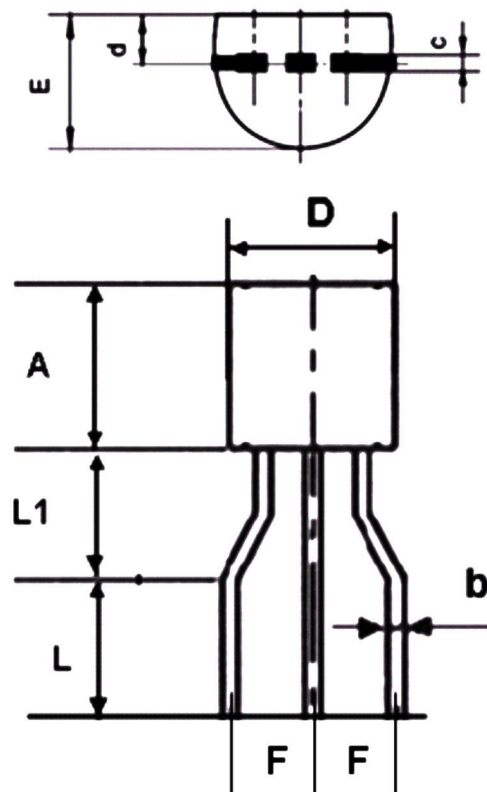

TO-92-AP 编带规格尺寸 TO-92 AMMOPACK DATA

单位:毫米/UNIT: mm

符号 SYMBOL	最小值 min	典型值 nom	最大值 max	符号 SYMBOL	最小值 min	典型值 nom	最大值 max
A	4.30		5.30	d	0.30		0.55
A1	4.30		5.20	T	3.20		4.20
DO	3.80	4.00	4.20	β	-	-	2° 10'
F1/F2	2.25	2.40	2.55	l1	2.50		
P	11.70	12.70	13.70	L1			11.00
PO	12.40	12.70	13.00	W	17.50	18.00	19.00
P2	5.95	6.35	6.75	W0	5.70	6.00	6.30
H	18.35		19.45	W1	8.50	9.00	9.75
H0	15.50	16.00	16.50	W2			0.50
H1			24.50	Δh	-1.00	0.00	1.00
H2	2.60		2.70	ΔP	-1.00	0.00	1.00
H3	9.50			t1	0.35		0.65
α	130°	135°	140°	t2			1.44

盒装量/BASE QUANTITY: 3000pcs/box

